



HEIDENHAIN



Product Information

EIB 392

Interface Electronics in
Cable Version

January 2008

EIB 392

Interface Electronics in Cable Version

- Interpolation and digitizing electronics in D-sub connector housing
- Integrated 16384-fold interpolation
- Input: Incremental encoders from HEIDENHAIN
- Output: Absolute position values to EnDat 2.2, Fanuc Serial Interface or Mitsubishi High Speed Serial Interface

Dimensions in mm

Tolerancing ISO 8015
ISO 2768 - m H
< 6 mm: ±0.2 mm

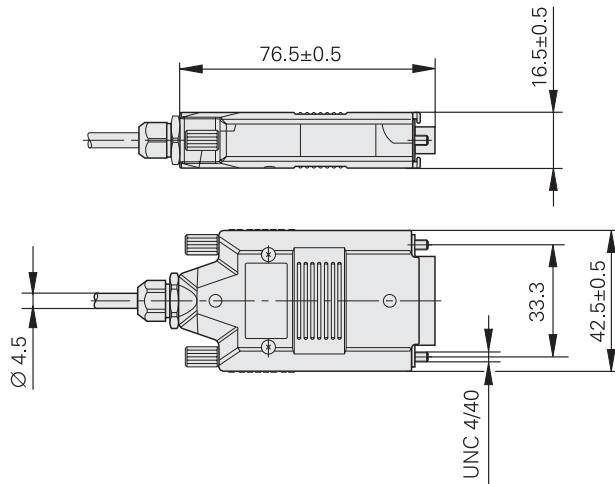

Specifications	EIB 392	EIB 392F	EIB 392M
Input			
Incremental signals	~ 1 V _{PP}		
Input frequency	≤ 400 kHz		
Electrical connection*	<ul style="list-style-type: none"> • D-sub connector (female), 15-pin • M23 connector (female), 12-pin 		
Cable length	≤ 6 m		
Output			
Absolute position values	EnDat 2.2	Fanuc Serial Interface	Mitsubishi High Speed Serial Interface
Order designation	EnDat 22	Fanuc 02	Mit 02-4 / Mit 02-2 ³⁾
Electrical connection	D-sub connector (male), 15-pin		
Cable length	≤ 100 m ¹⁾	≤ 20 m ²⁾	
Interpolation	≤ 16384-fold (depending on the encoder)		
Power supply	5 V ± 5% measured at EIB		
Current consumption	≤ 130 mA (without load, without encoder)		
Operating temperature	0 °C to 70 °C		
Storage temperature	-30 °C to 70 °C		
Vibration 55 to 2000 Hz Shock 11 ms	100 m/s ² (IEC 60068-2-6) 200 m/s ² (IEC 60068-2-27)		
Protection	IP 40		
Weight	140 g (EIB without cable with electronics)		

* Please indicate when ordering

¹⁾ with HEIDENHAIN cable; supply voltage of 5 V ± 5% at the EIB must be maintained







²⁾ with HEIDENHAIN cable; I_{Encoder} ≤ 150 mA; greater cable lengths upon request

³⁾ Mitsu01 upon request

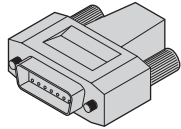
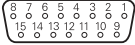
Electrical Connection

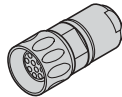
Pin Layout

EIB input



  					  								
	Power supply				Incremental signals						Other signals		
	12	2	10	11	5	6	8	1	3	4	/	7	9
	4	12	2	10	1	9	3	11	14	7	5/13/15	8	6
	U _P	Sensor U _P	0V	Sensor 0V	A+	A-	B+	B-	R+	R-	Vacant	H/L1 ¹⁾	L/L2 ¹⁾
	Brown/ Green	Blue	White/ Green	White	Brown	Green	Gray	Pink	Red	Black	/	Violet	Yellow

Shield on housing; **U_P** = power supply voltage

Sensor: The sensor line is connected internally with the corresponding power line

¹⁾ Limit position signals only for LIF 481/LIDA 48x; color assignment applies only to connecting cable

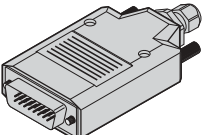
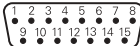
EIB output

15-pin D-sub connector, male   														
	Power supply				Incremental signals ¹⁾						Absolute position values			
	4	12	2	10	1	9	3	11	14	7	5	13	8	15
EnDat	U _P	Sensor U _P	0V	Sensor 0V	A+ ¹⁾	A- ¹⁾	B+ ¹⁾	B- ¹⁾	R+ ¹⁾	R- ¹⁾	DATA	DATA	CLOCK	CLOCK
Fanuc	● — ●		● — ●								Serial DATA	Serial DATA	Request	Request
Mitsu- bishi											Serial DATA	Serial DATA	Request Frame ²⁾	Request Frame ²⁾

Shield on housing; **U_P** = power supply voltage







Sensor: The sensor line is connected internally with the corresponding power line

Vacant pins or wires must not be used!

¹⁾ Only for adjusting; do not use in normal operation

²⁾ Do not use on Mit 02-2

Connecting Elements and Cables

<p>EIB 392 with D-sub connector (female) 15-pin</p> 	<p>Adapter cable complete</p>		
<p>EIB 392 with M23 connector (female) 12-pin</p> 	<p>EIB 392 (EnDat) ID 628 186-xx</p> 		<p>EIB 392 F (Fanuc) ID 628 184-xx</p> 
<p>EIB 392 M (Mitsubishi*) 20-pin 10-pin ID 366 419-xx ID 630 856-xx</p> 	<p>Components for the EIB</p>		
<p>D-sub connector ID 315 650-14</p> 			

* Mit 02-2 upon request

Configuration of the EIB 392

In order for the EIB 392 to function correctly together with the encoder, certain encoder parameters must be stored in the EIB 392 (such as the number of signal periods, nominal increment of the reference marks, encoder ID, etc.). Only HEIDENHAIN can program this information. This information is also printed on the ID label. It can also be read out via the EnDat interface.

Information on the ID label

The **data interface** designates the type of interface for transmission of the position values at the output of the EIB.

Line count or signal period

For rotatory encoders the number of signal periods per revolution is indicated. For linear encoders the signal period is shown in μm .

The **encoder ID** indicates the type of encoder that can be connected, e.g. EnDat 22:

- 00 Incremental linear encoder without distance-coded reference marks
 - 10 Incremental linear encoder with distance-coded reference marks
 - 80 Incremental rotary or angle encoder without distance-coded reference marks
 - 90 Incremental rotary or angle encoder with distance-coded reference marks
- For the EnDat interface this value is stored in word 14 of the EnDat 2.1 parameters.

The **nominal increment N of the reference marks** is indicated in signal periods if the connected encoder has distance-coded reference marks (EnDat 2.2 encoder ID = 10 or 90).

Example:

Information on the ID label for the connection of an ERM 280 (line count: 1024) to the EnDat 2.2 interface via an EIB 392
Data interface: EnDat22
Encoder ID: 80
Line count or signal period: 1024
Nominal increment of the reference marks: –
Interpolation: 16384

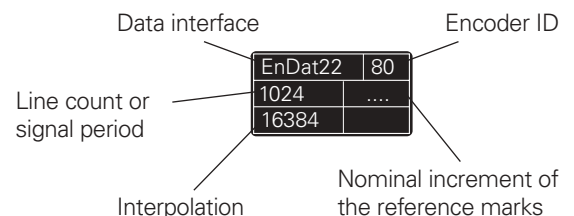

HEIDENHAIN

DR. JOHANNES HEIDENHAIN GmbH
Dr.-Johannes-Heidenhain-Straße 5
83301 Traunreut, Germany
☎ +49 (86 69) 31-0
FAX +49 (86 69) 50 61
E-Mail: info@heidenhain.de

www.heidenhain.de

For more information

- *Interface Electronics Product Overview*

